

MODEL SD330 TECHNICAL SPECIFICATIONS(DIN)

Style	Front load
Tape Drive System	Single Capstan Drive
Cartridge	Philips type compact cassette
Track System	Compatible Stereo 4-track 2-channel
Tape Speed	4.75 cm/sec.
Heads	2 Head System
Composition	Rec/Play: Super Hard Metal Alloy
	Erase: Dual gap Ferrite
Motor	1 Motor System
	DC Servo Motor
Overall Frequency Response at - 20 dB	
Normal Tape	30 Hz ~ 16 kHz
CrO ₂ Tape	30 Hz ~ 17 kHz
Metal Tape	30 Hz ~ 18 kHz
Signal-to-Noise Ratio:	
Dolby C (ON)	70 dB
Dolby (OFF)	56 dB
Wow and Flutter	
DIN WTD	0.15%
Outputs	
Line Level/Impedance	600 mV/50 kΩ
Headphone Level/Impedance	50 mV/50Ω
Input (Level at 0 VU)	
Line Sensitivity/Impedance	70 mV/50 kΩ
Mic Sensitivity/Impedance	0.3 mV/10 kΩ
Fast Rewind Time	90 sec. (C-60)
Fast Forward Time	90 sec. (C-60)
Power Requirement	110-120/220-240 V AC, 50/60 Hz
Power Consumption	17 W
Dimensions (W x H x D)	416 x 100 x 194 mm
Weight	3.2 kg

Model SD230/SD330

OWNER'S MANUAL

STEREO CASSETTE DECK

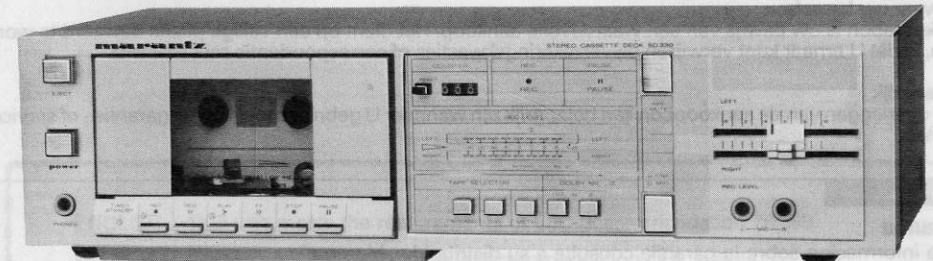
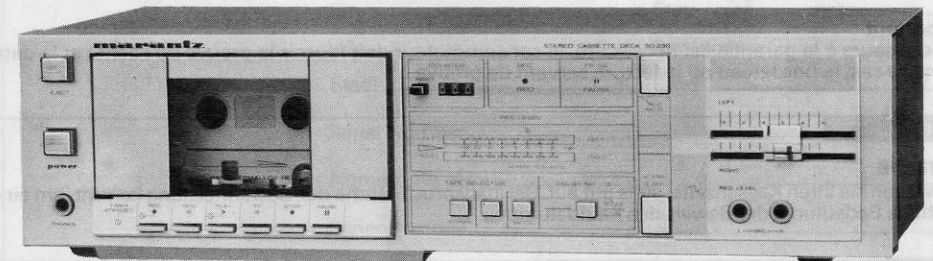

marantz®

Model SD230

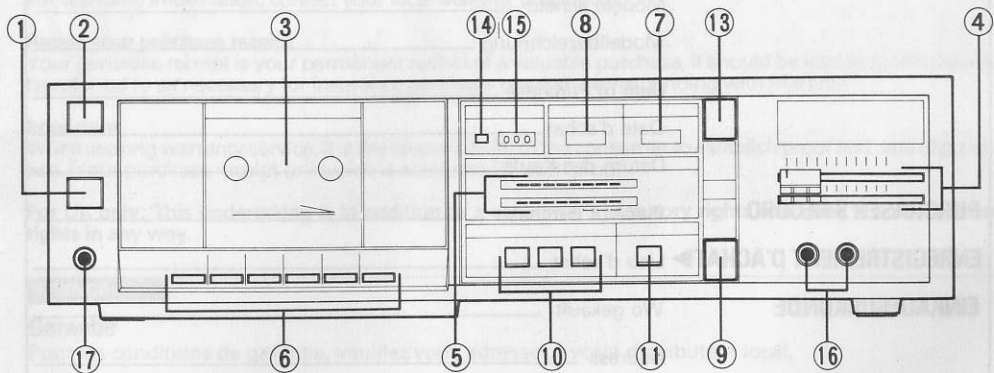

Model SD330

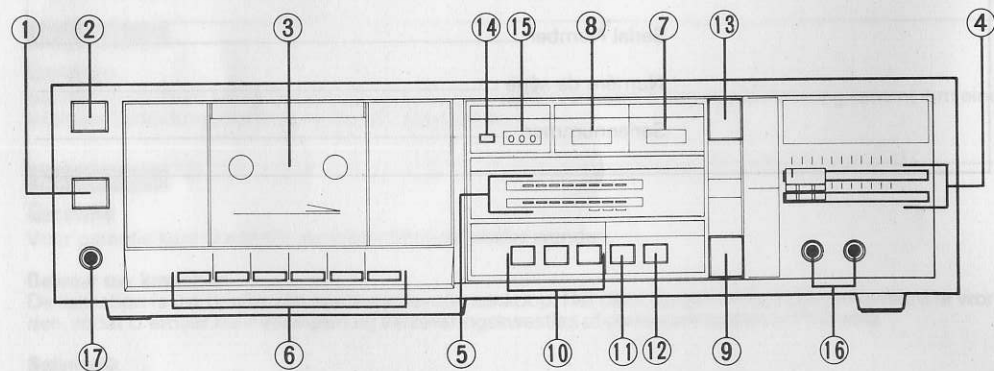

Figure 1. Front Panel
Figure 1. Face Avant
Abbildung 1. Geräteorderseite

FOREWORD

Your Marantz product has been specially prepared to comply with the household power and safety requirements that exist in your region. This product has a 4-position voltage selector (110/120/220/240V) on the rear panel (A, N and T versions). Since the voltage has been adjusted as shown below upon shipment from the factory, please check the third alphabetical letter of the serial number and refer to the following table to note the characteristics of the model in your possession:

Suffix	Voltage
A -	240V AC, 50/60 Hz
C -	120V AC, 60 Hz
U -	120V AC, 60 Hz
N -	220V AC, 50/60 Hz
T -	240V AC, 50/60 Hz

FOR UNITS SOLD IN THE UNITED KINGDOM

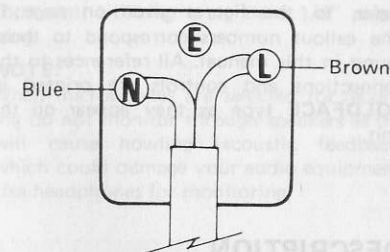

IMPORTANT

The wires in the mains lead are coloured in accordance with the following code:

- Blue - Neutral
- Brown - Live

As the colours of the wires may not correspond with the terminal identification in your plug, proceed as follows:

- Connect the brown wire to the terminal marked "L" or coloured brown or red.
- Connect the blue wire to the terminal marked "N" or coloured blue or black.

For 13A plugs, conforming to BS 1363, use a 3A fuse.

For other plugs, use a 5A or lower fuse in the plug or adaptor or at the distribution board.

NOTE FOR U.K.:

Recording and playback of any material may require consent. For information please refer to the
 - Copyright Act 1956
 - Dramatic & Musical Performers Act 1958
 - Performers Protection Acts 1963 & 1972
 and to any subsequent statutory enactments and orders.

ABOUT THIS MANUAL

Refer to the figures given on page 1. The callout numbers correspond to those found in this manual. All references to the connections and controls are printed in **BOLDFACE** type as they appear on the unit.

DESCRIPTION

REAR PANEL

LINE INPUTS

Should be connected to the set of tape output jacks on your receiver.

LINE OUTPUTS

Should be connected to the set of tape output jacks on your amplifier.

AC POWER CONNECTION

The correct voltage for operating your unit is written on the rear panel. Be sure the **POWER** pushswitch is out before plugging the AC line cord into an electrical outlet.

FRONT PANEL

① POWER SWITCH

To turn the unit On and Off.

② EJECT BUTTON

To open the cassette compartment.

③ CASSETTE COMPARTMENT

④ RECORD LEVEL CONTROLS

Used to adjust the record levels. To increase the record levels, move the controls upwards.

⑤ PEAK LEVEL INDICATORS

The Left and Right **PEAK LEVEL** indicators accurately follow the strength of music signals. Set the **RECORD LEVEL** controls so that the **PEAK LEVEL** displays do not travel into red in the scale. Occasional flashes are acceptable but if the signal is allowed to consistently illuminate the red zone of the display audible distortion will occur.

⑥ TAPE TRANSPORT CONTROLS

PAUSE BUTTON:

To stop a tape in **PLAY** or **RECORD** mode.

STOP BUTTON:

To stop a tape in any mode.

FAST FORWARD BUTTON:

For rapid advancement to any desired point of the tape.

PLAY BUTTON:

To play back a tape.

REWIND BUTTON:

To rapidly rewind a tape.

⑦ PAUSE INDICATOR

Lights when the deck is in the **PAUSE** mode.

⑧ REC INDICATOR

Lights when the deck is in the **Record** mode.

⑨ INPUT SELECTOR SWITCH

Selects the recording source. When depressed the **MIC** input is selected; when released the **LINE** input is selected.

⑩ TAPE SELECTOR

Selects the proper bias and equalization to suit the most common types of cassette tapes:

- NORMAL — for normal ferric oxide tapes.
- CrO₂ — for chromium dioxide and other tapes requiring 70 μ S equalization and high bias.
- METAL — for metal tapes.

⑪ DOLBY NR SWITCH

Activates the Dolby Noise Reduction circuit.

⑫ DOLBY B-C NR SWITCH (SD330 ONLY)

OUT position: Dolby **B** noise reduction circuit operates.

IN position: Dolby **C** noise reduction circuit operates.

⑬ REC MUTE BUTTON

When depressed during recording momentarily prevents the audio input signal from being recorded. During the blank recording the signal can still be monitored through the **PHONES** or the **LINE OUTPUT** jacks and observed on the **PEAK LEVEL** display.

⑭ RESET BUTTON

To reset the **TAPE COUNTER** to "000".

⑮ TAPE COUNTER

Can be used for easy reference and indexing of selections.

⑯ MICROPHONE JACKS

Will accept any low impedance microphone (optional) utilizing a standard 1/4" phone plug.

NOTE:

When microphones are selected for recording do not monitor through speakers as this will cause howling (acoustic feedback) which could damage your audio equipment. Use headphones for monitoring.

⑰ PHONES JACK

Accepts headphones (optional) utilizing a standard stereo phone plug.

MAKING OPTIMUM CASSETTE RECORDINGS

TAPE AND BRAND OF TAPE TO USE

In cassette recording the type and brand of cassette you use has a great influence in the quality of your recordings. Therefore it is advantageous to purchase the highest quality cassettes available. Chromium dioxide (CrO₂) and metal tapes generally provide better fidelity than normal ferric oxide tapes. When using these kinds of tapes set the **TAPE SELECTOR** switch on the unit in the correct position to suit the characteristics of the tape.

We recommend the use of cassettes with a recording capacity of 90 minutes or less. In production the performance of our cassette decks is tested using the following tapes:

Type of Tape	Ref. Tape	Market Name
Normal	TDK AC-212 (C-60)	TDK D
CrO ₂	TDK AC-512 (C-60)	TDK SA
Metal	TDK AC-711 (C-60)	TDK MA TDK MA R

PROPER RECORDING LEVEL

One of the beauties of music is its dynamic range, in other words, the contrast between very soft and very loud passages. To capture this contrast on tape requires that the recording levels be set so that the loudest passages do not saturate the tape and cause distortion. Yet the recording levels should not be set too low or the soft passages would simply disappear in the residual noise.

If for example you are recording from a record, you should at the outset find the loudest section of the record. Insert a cassette in your tape deck and press the **PAUSE** and **REC** buttons simultaneously. You can thus adjust the recording level without actually recording on the tape.

Start the record over at the beginning and depress the **PAUSE** button to commence recording. If after setting the recording levels as explained above the record begins with a soft musical passage, you might suspect from the **PEAK LEVEL** display readings that you set the levels too low. Do not give into the temptation of changing them. Keep in mind that the level readings, when placed in proper perspective with actual relative loudness levels will fall into the following areas:

- Broadcast human voice: from -10 dB to -5 dB
- Loud music (fortissimo): Approximately +1 dB
- Soft music (pianissimo): Approximately -15 dB
- Average music level: from -10 dB to -5 dB

TO CLEAN AND DEMAGNETIZE HEADS

The RECORD/PLAYBACK and ERASE heads are the most important parts of the cassette deck. As the tape rubs against the heads during record and playback brown oxide deposits from the tape accumulate on the heads, guides and pinch roller. Even the best cassette tapes will shed some particles of oxide. The accumulation of this oxide will cause loss of high frequency, loss of sound volume, intermittent sound dropout and unsatisfactory results when recording or erasing the tape. If the oxide is allowed to build up it may cause the heads to wear out prematurely, causing permanent damage.

To clean the tape path, use a cotton swab and methylated spirit (available at any pharmacy). Please note that common "rubbing alcohol" should not be used because of its water content.

Dip the cotton swab in alcohol and clean the tape heads, capstan, guides, pinch roller until no more oxide can be picked up. If you can see a stripe of brown oxide around the perimeter of the pinch roller it is time to clean the entire tape path.

TO PROTECT VALUABLE RECORDINGS

In the RECORD mode information previously recorded on the tape will automatically be erased. To prevent this from happening use a small screwdriver to break out one or both safety tabs (see Figure 3 for side A). It is possible to restore the recording capability of either side of the cassette by covering the opening with cellophane tape (see Figure 4 for side A).

NOTE ON INSTALLATION

When the deck is installed on or near other audio equipment hum sometimes occurs. Position the equipment so that the hum ceases. Always install the unit horizontally.

DOLBY B AND DOLBY C NOISE REDUCTION SYSTEMS

DOLBY B NR

The Dolby B Noise Reduction system increases the level of low volume mid and high frequency signals during recording and reduces the level of these signals by an identical amount during playback. As a result the playback signal is identical to the original source signal but the level of background noise generated by the tape and tape recorder is reduced.

DOLBY C NR

The Dolby C Noise Reduction system is similar to the B type. In the C system however, as the ranges to be increased and decreased during recording and playback are considerably extended the level of background noise is greatly reduced.

TIMER PLAY AND RECORDING

This feature requires the use of an outside timer. Set the timer to the desired time (the deck is to play or record as per the timer's instructions). Plug the deck and associated equipment into the control timer. To set the cassette deck to operate at the pre-selected time, proceed as follows:

For recording:

1. Load the cassette and set the tape selector switch to the type used.
2. Set the unit into record mode and adjust the record level as previously described under "PROPER RECORDING LEVEL".
3. Set the timer from manual control to automatic. This will remove power the tape deck.
4. After five seconds, depress the **RECORD** button to preset the record function.

The deck is now ready for recording at the preset time.

For playback:

1. Repeat No. 1 above.
2. Repeat No. 3 above.
3. After five seconds, depress the **PLAY** button to preset the playback function.

The deck is now ready to playback at the preset time.

IN CASE OF DIFFICULTY

Only the most competent and qualified technicians should be allowed to service your unit. The Marantz company and its factory-trained service people have the knowledge and special equipment needed for repair and calibration of this precision instrument.

In the event of difficulty refer to your dealer or write to one of the locations listed at the end of this manual for the name and address of the Marantz service station nearest your home or business. Please include the model and serial number of your unit together with a description of what you feel is abnormal in its behaviour.

Type of Tape	Ref. Type	Market Name
Normal	TDK AC 315 IC 301	TDK D
Hi-Fi	TDK AD 812 IC 301	TDK SA
Multitrack	TDK AC 711 IC 301	TDK MA

- REAR PANEL SIGNAL CONNECTIONS
- BRÄNCHEMENT A LA FACE ARRIERE
- RÜCKSEITIGE ANSCHLÜSSE
- SIGNAL AANSLUITING OP ACHTERPANEEL
- CONEXIONES AL PANEL POSTERIOR
- BAKKANLENS ANSLUTNINGAR

YOUR STEREO CASSETTE DECK

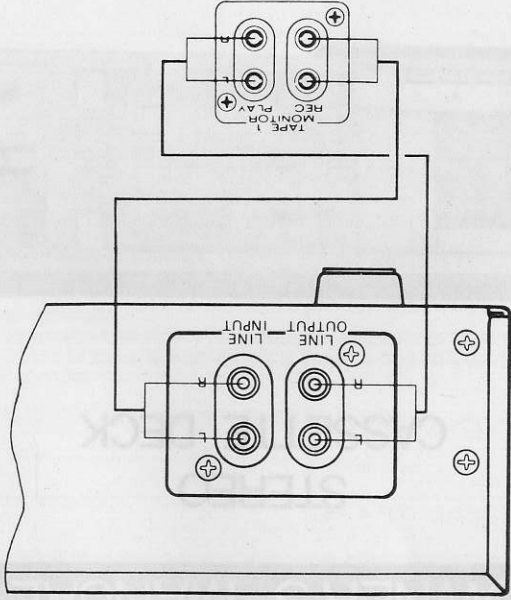

Your amplifier or receiver
 Ihr Steuergerät oder Verstärker
 Uw Verstärker or receiver
 Su amplificador o receptor
 Din förstärkare eller receiver

Caution:
 Do not plug the tape deck into a DC outlet, as serious damage will occur.

Attention:
 Ne branchez jamais votre appareil à une source de tension continue, il en résulterait de sérieux détériorations.

Hinweis:
 Verbinden sie das gerät nie mit einer gleichstromquelle, das gerät wird dadurch schwer beschädigt.

Waarschuwing:
 Sluit het tape deck niet aan op een DC uitgang, want dit zal ernstige schade veroorzaken.

Attention:
 No haga la toma de red en una base de corriente continua, dado que produciría un grave daño.

Varning:
 Stoppa inte in nätkontakten i ett likströmsuttag eftersom allvariga skador då uppstår.

MARANTZ S.A.
 326 Avenue Louise Bte 32
 1050 Brussels
 Belgium

MARANTZ DENMARK
 Bregnerdvej 132b
 3460 Birkerød
 Denmark

MARANTZ NORISKE A.S.
 Sam Eydnes Vel 11
 1412 Sofiemyr
 Norway

MARANTZ AUDIO U.K. LTD.
 Unit 15/16
 Saxon Way Industrial Estate
 Moor Lane
 Harmondsworth UB7 0LW
 Great Britain

Figure 4.
 Abbildung 4.

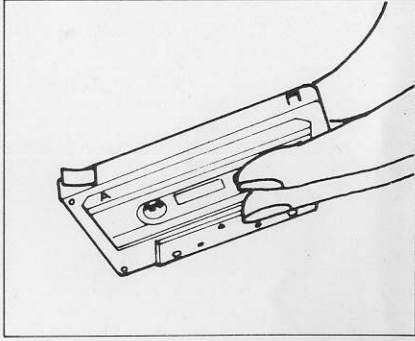
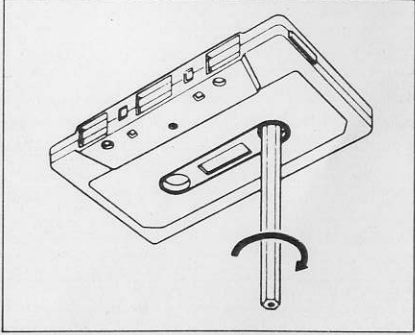

Figure 2. Cassette Preparation
 Figure 2. Préparation de la Cassette
 Abbildung 2. Cassettenvorbereitung



MARANTZ GMBH AUSTRIA
 2380 Perchtoldsdorf
 25 Franz Lisztgasse
 Austria

MARANTZ FRANCE
 4 rue Bernard Palissy
 92600 Asnières
 France

MARANTZ NEDERLAND B.V.
 Wagenmakersweg 3
 3449 HV Woerden
 The Netherlands

MARANTZ SVENSKA A.B.
 Svarviksvägen 56
 161 12 Bromma
 Sweden

MARANTZ GERMANY GMBH
 Max Planckstrasse 22
 6072 Dreieich 1
 Germany

MARANTZ BELGIUM
 1080 Brussels
 4 rue Auguste Van Zandestraat
 Belgium

Figure 5. Packing Instructions
 Figure 5. Instructions d'emballage
 Abbildung 5. Packungsanleitung

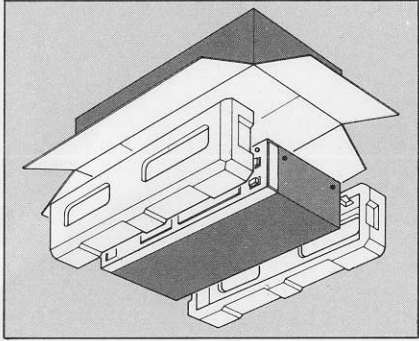
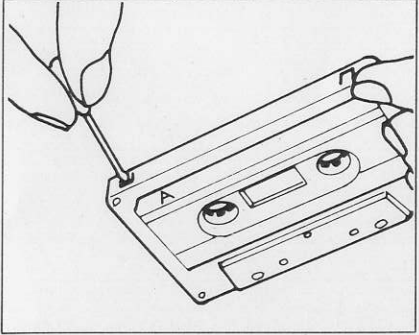
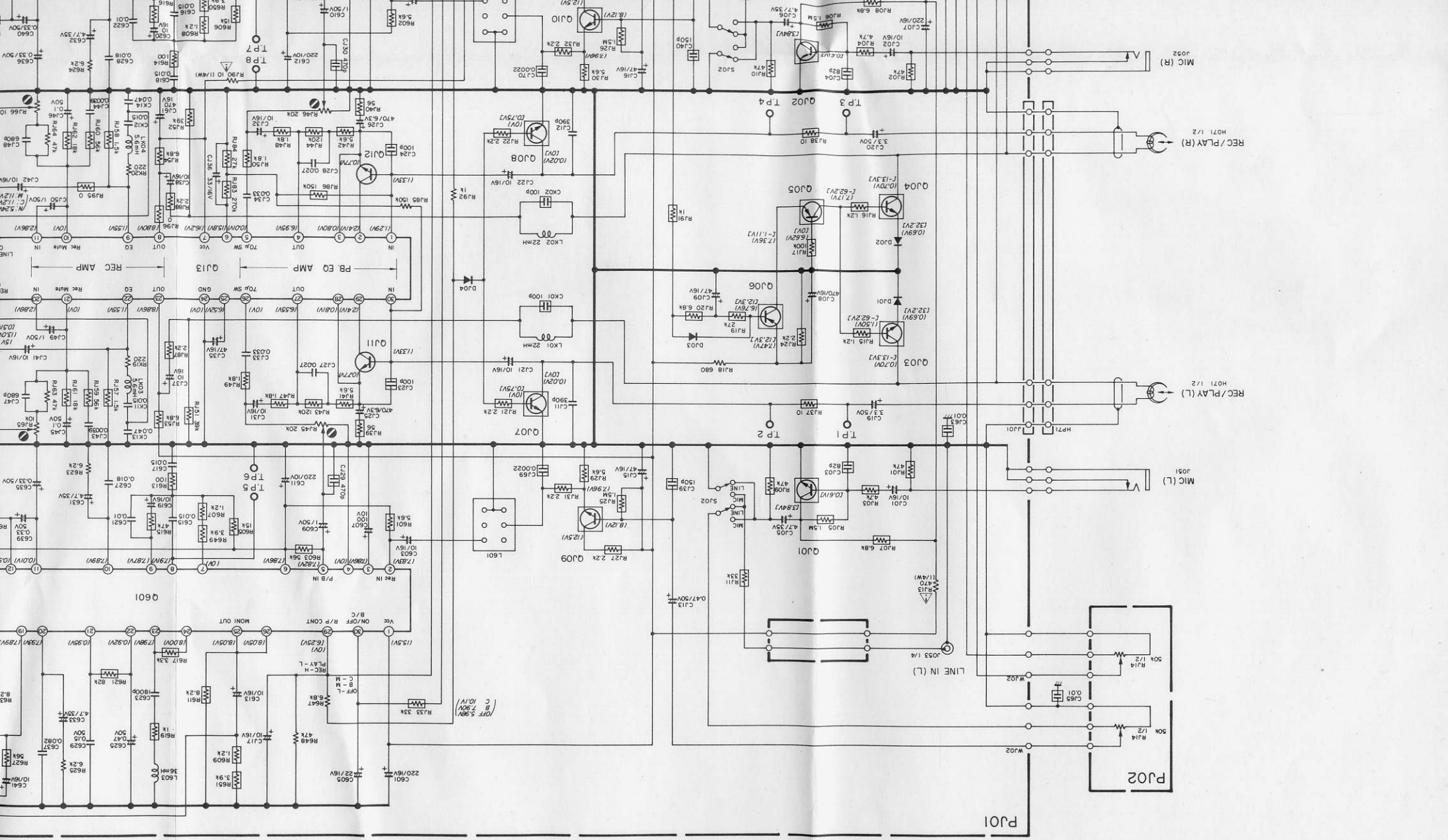
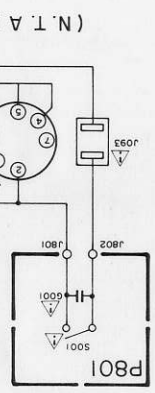
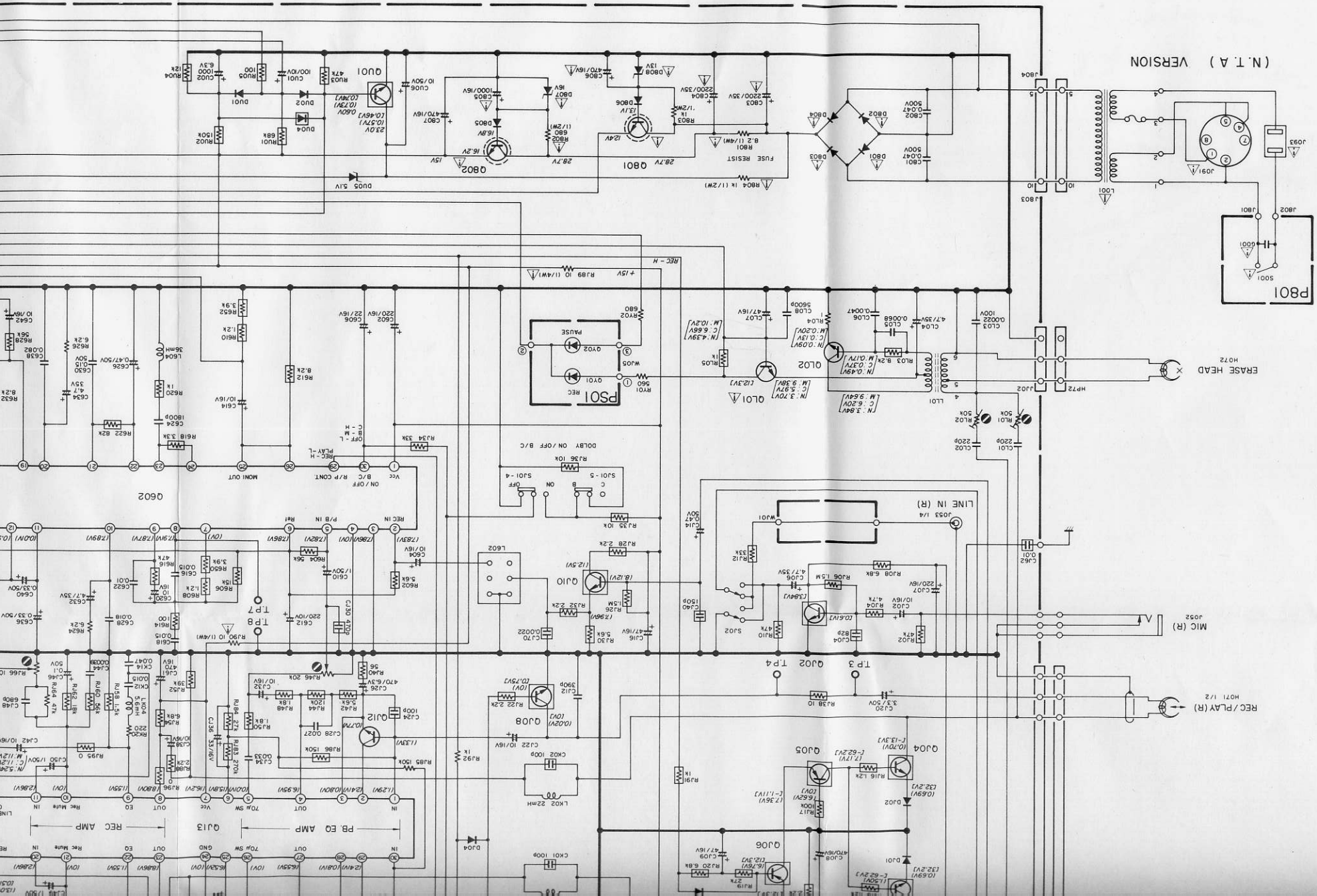

Figure 3.
 Abbildung 3.







FRASE HEAD H072

MIC (R) J092

REC / PLAY (R) H071 1/2

NOTE ON SAFETY :
 Symbol ⚠ Fire or electrical shock hazard. Only original parts
 Any other component substitution (other than symbol ⚠)

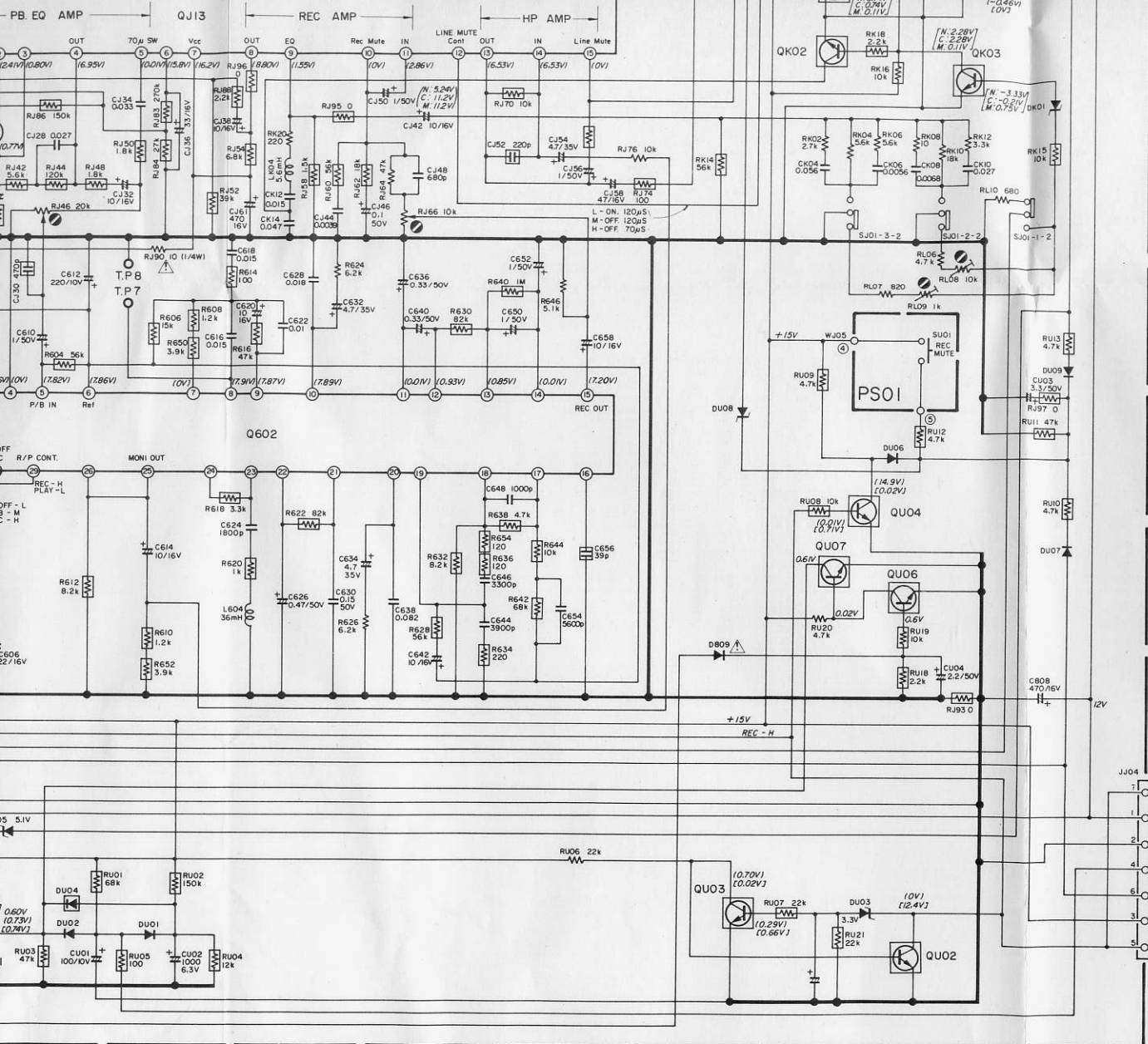

HT326342B1
25C2634 (R,S)

QLO2
HT313832B0
25C1383 (R,S)

Q801, Q802
HT403131E0
25D313 (E)

QJ01, QJ02
QJ09, QJ10
HX410301S2
25D1030 (S)

QJ05, QJ06
HX111621AZ
25A1162 (G)

QJ11, QJ12
HT318451U1
25C1845 (U)

QJ13
HC10053010
HA12051

DU01
HD10004021
0A91A

DU02, DU06
DU07, DU09
DB05, DB06
DJ03, DJ04
HD20001001
SI DIODE

DU03
HD30001021
MA1033M 3.3V

DU05
HD30004021
MA1051M 5.1V

DU08
HD30003021
MA1047M 4.7V

DB01 ~ DB04
DB09
HD20015032
DS135D

DB07
HD30020021
MA1160M 16V

DB08
HD30022021
MA1130M 13V

DK01
HD30031091
WZ-081 8.1V

D601
HD30006021
MA1062M 6.2V

DJ01, DJ02
HD20001216
IS2473C

PX01
HI10801320
LT-1056

DU04
HZ2000302Z
MA151K

TOP VIEW

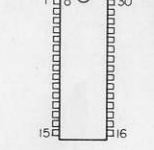

HA12051
QJ13

HA12038NT
Q601, Q602

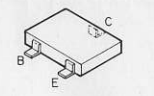

25D1030 (S)
QJ01, QJ02
QJ09, QJ10

25C2712 (G)
QU01 ~ QU07, QK01 ~ QK03
QJ03, QJ04, QJ07, QJ08

25A1162 (G)
QJ05, QJ06

- CHIP RESISTOR
- CHIP CAPACITOR
- CHIP TRANSISTOR
- CHIP DIODE

MUTE
L : ON : 120μ : 0V
M : OFF : 120μ : 5V
H : OFF : 70μ : 10V

VOLTAGE
STOP } V
/ / - PLAY }
/ / - REC }

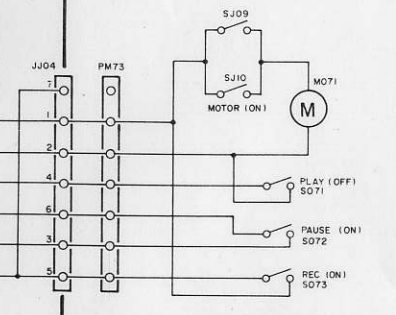

SCHEMATIC DIAGRAM FOR Model SD330

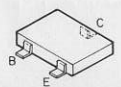
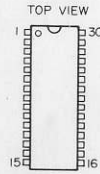
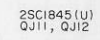
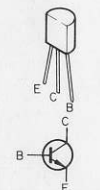
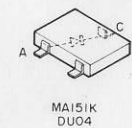
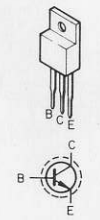
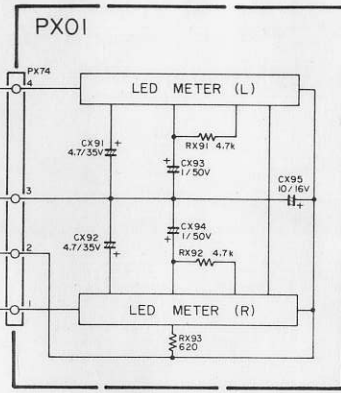
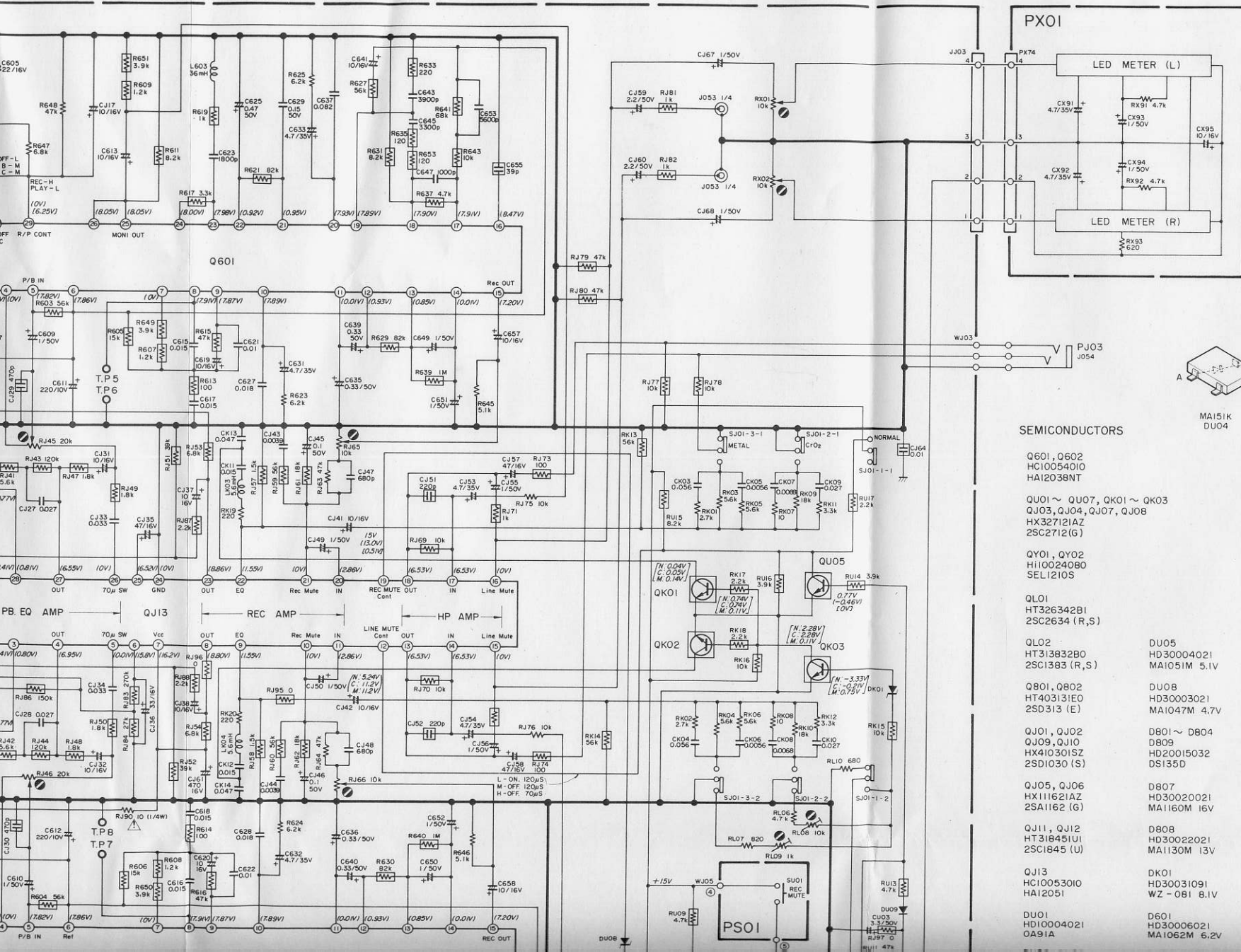

SEMICONDUCTORS

- Q601, Q602
HC10054010
HA12038NT
- QU01 ~ QU07, QK01 ~ QK03
QJ03, QJ04, QJ07, QJ08
HX327121AZ
2SC2712(G)
- QY01, QY02
HI10024080
SEL1210S
- QLO1
HT326342B1
2SC2634 (R, S)
- QLO2
HT313832B0
2SC1383 (R, S)
- DU05
HD30004021
MA1051M 5.1V
- DU08
HD30003021
MA1047M 4.7V
- Q801, Q802
QJ01, QJ02
QJ09, QJ10
HX410301SZ
2SD1030 (S)
- DB01 ~ DB04
DB09
HX410301SZ
DS135D
- QJ05, QJ06
HX111621AZ
2SA1162 (G)
- QJ11, QJ12
HT318451U1
2SC1845 (U)
- DB07
HD30020021
MA1160M 16V
- DB08
HT318451U1
MA1130M 13V
- DK01
HC10053010
HA12051
- D601
HD30006021
MA1062M 6.2V
- DU01
HD10004021
OA91A
- DU09
HC10053010
HA12051
- 2SD1030 (S)
QJ01, QJ02
QJ09, QJ10